

537 Series Elvox Videointercom Kits

Elvox Videointercom kits are packaged complete systems. Each kit contains all of the components required to install a complete 1-1 video entry system including 100 ft of cable.

Each kit contains:

- 1 537M Monitor
- 1 537U Camera/Speaker/Mic
- 1 15V AC Transformer
- 100 ft 2/063 cable (2c + coax)
- 1 Entry Panel (see below for kit model number/panel)
 - 537E Low Profile - Surface
 - 537A Vandal-proof - Recess
 - 537G Galileo - Recess
 - 537S Multi-System -Recess
 - 537T Patavium - Recess

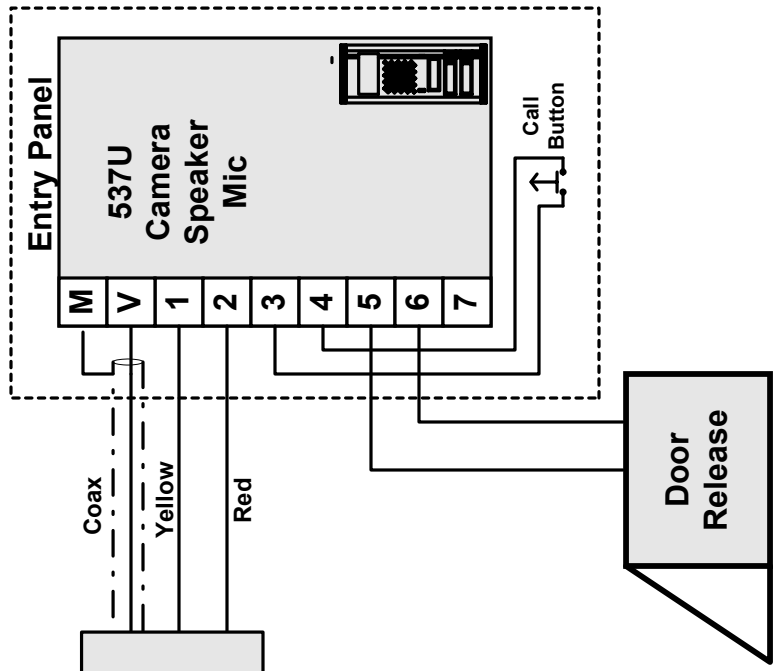
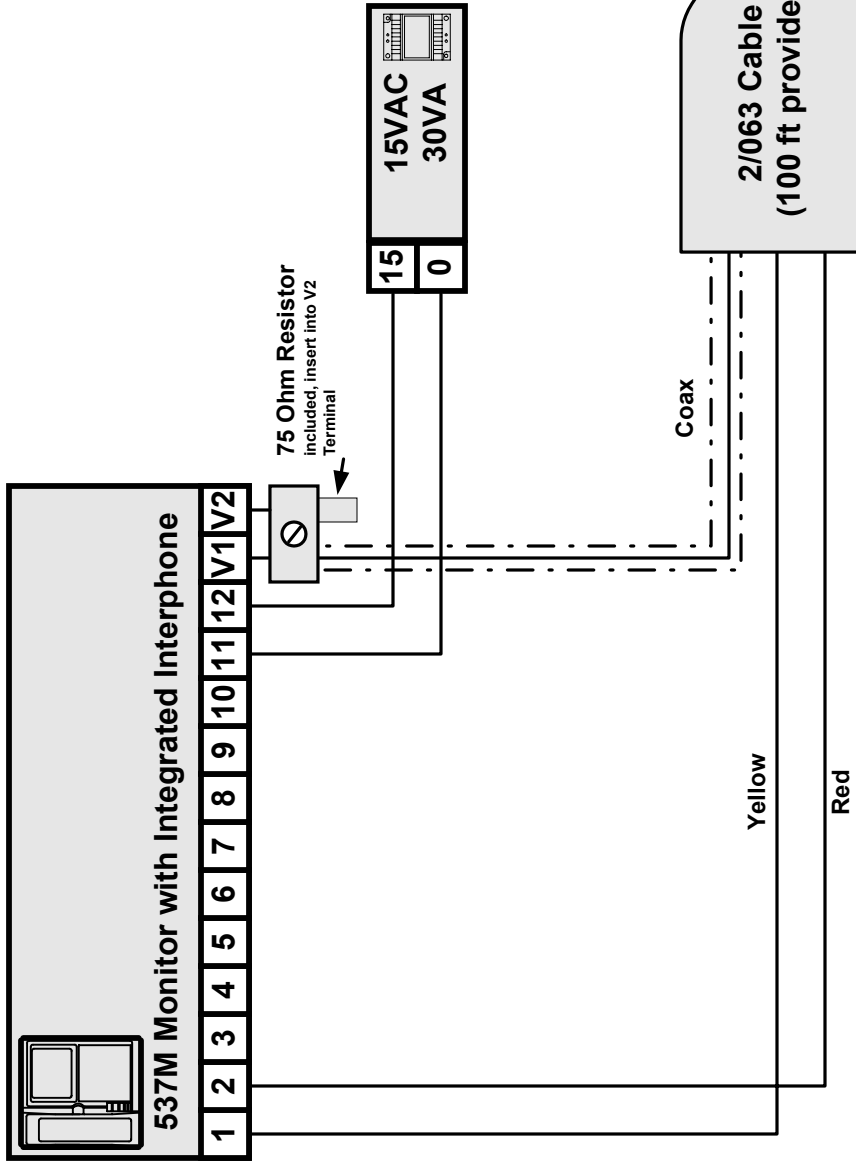

537 Kits

- 537E Complete videointercom kit with Low Profile-Surface Entry Panel
- 537A Complete videointercom kit with VandalSecurity-Recess Entry Panel
- 537G Complete videointercom kit with Galileo-Recess Entry Panel
- 537S Complete videointercom kit with Multi-System-Recess Entry Panel
- 537T Complete videointercom kit with Patavium-Recess Entry Panel

VIDEO ENTRY SYSTEMS
AUTOMATIC DIAL SYSTEMS

T E C H N O L O G Y A N D D E S I G N

ALPHA COMMUNICATIONS

42 Central Drive, Farmingdale NY 11735-1202

Tel: 631-777-5500

Fax: 631-777-5599

Email: info@alpha-comm.com Web www.alpha-comm.com

Adding Optional 2nd Monitor to any 537 Kit:
Order:
 Qty 1 537M Monitor
 Qty 1 15V AC 30VA Transformer

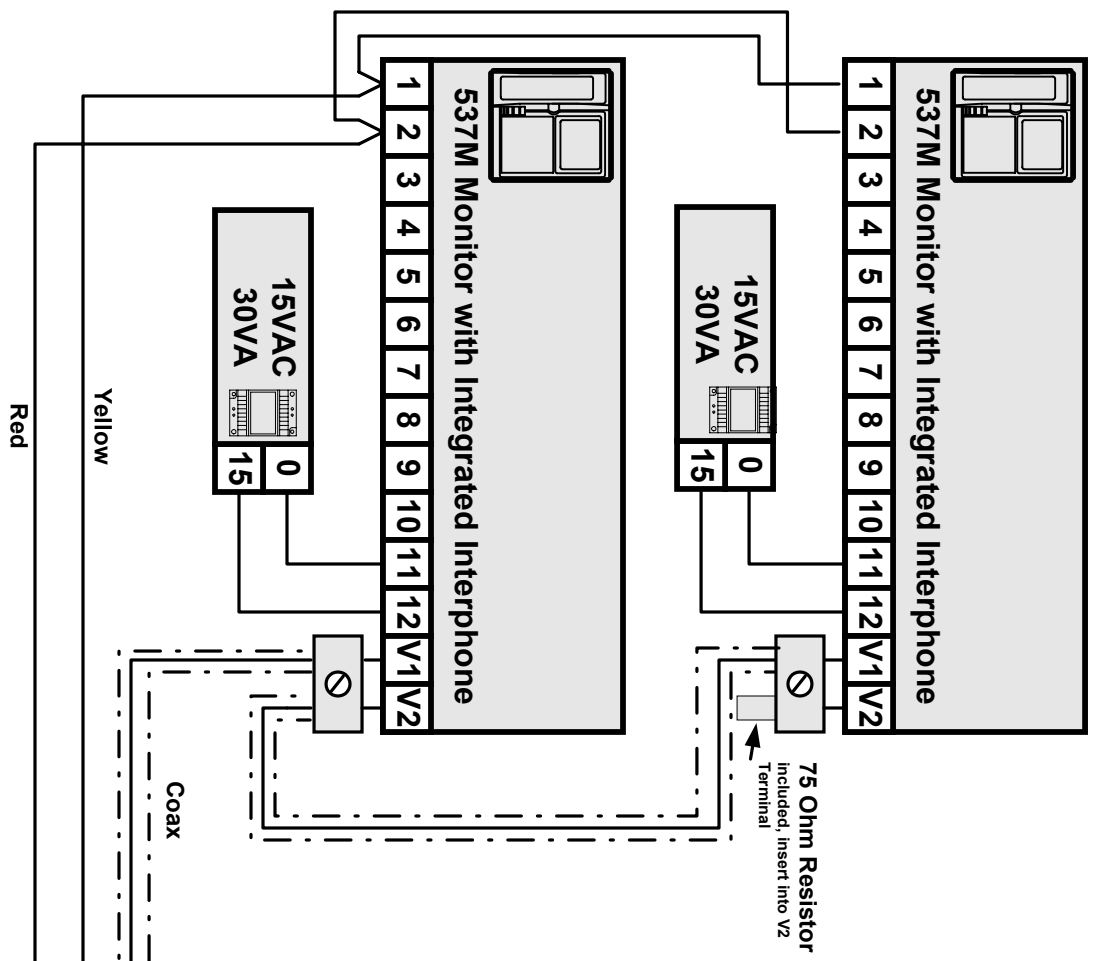

2/063 Cable
(100 ft provided)

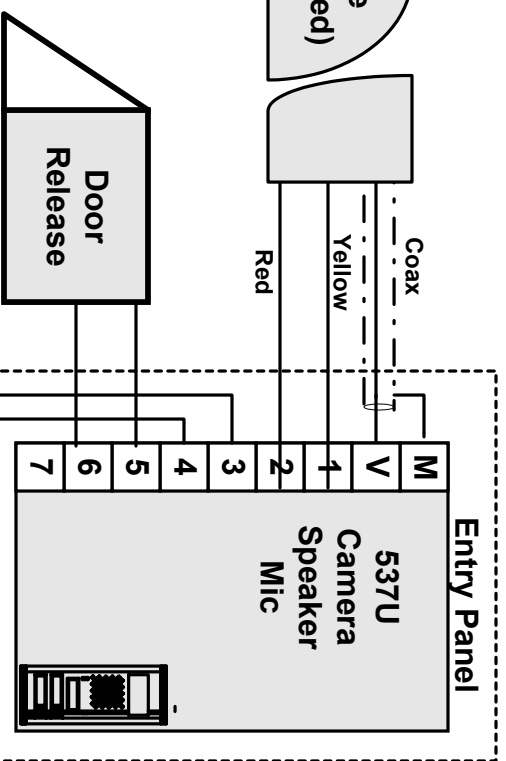

ETVAX TECHNOLOGY AND DESIGN

VIDEO DOOR ENTRY SYSTEMS
 AUTOMATIC GATE SYSTEMS
 TELEPHONE SYSTEMS

ALPHA COMMUNICATIONS
 42 Central Drive, Farmingdale NY 11735-1202
 Tel: 631-777-5500 Fax: 631-777-5599
 Email: info@alpha-comm.com Web www.alpha-comm.com

**Adding Optional Extension Handset to any
537 Kit:
Order:
Qty 1 537C Handset**

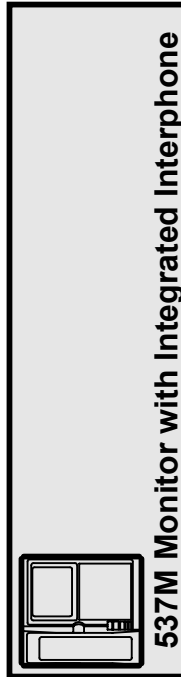

75 Ohm Resistor
included, insert into V2
Terminal

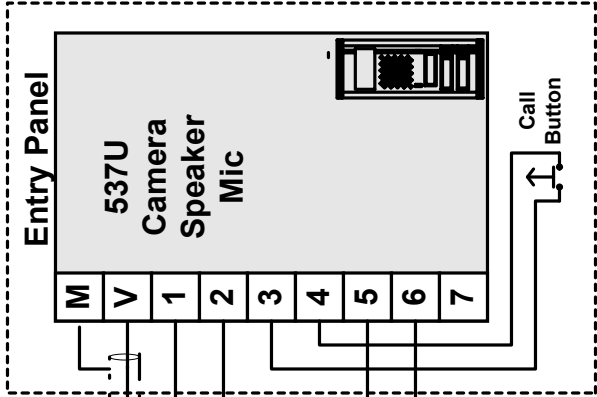
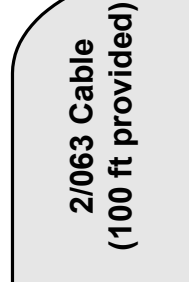

VIDEO DOCUMENT SYSTEMS
AUTOMATIC DIAL SYSTEMS

T E C H N O L O G Y A N D D E S I G N

ALPHA COMMUNICATIONS

42 Central Drive, Farmingdale NY 11735-1202
Tel: 631-777-5500 Fax: 631-777-5599
Email: info@alpha-comm.com Web www.alpha-comm.com

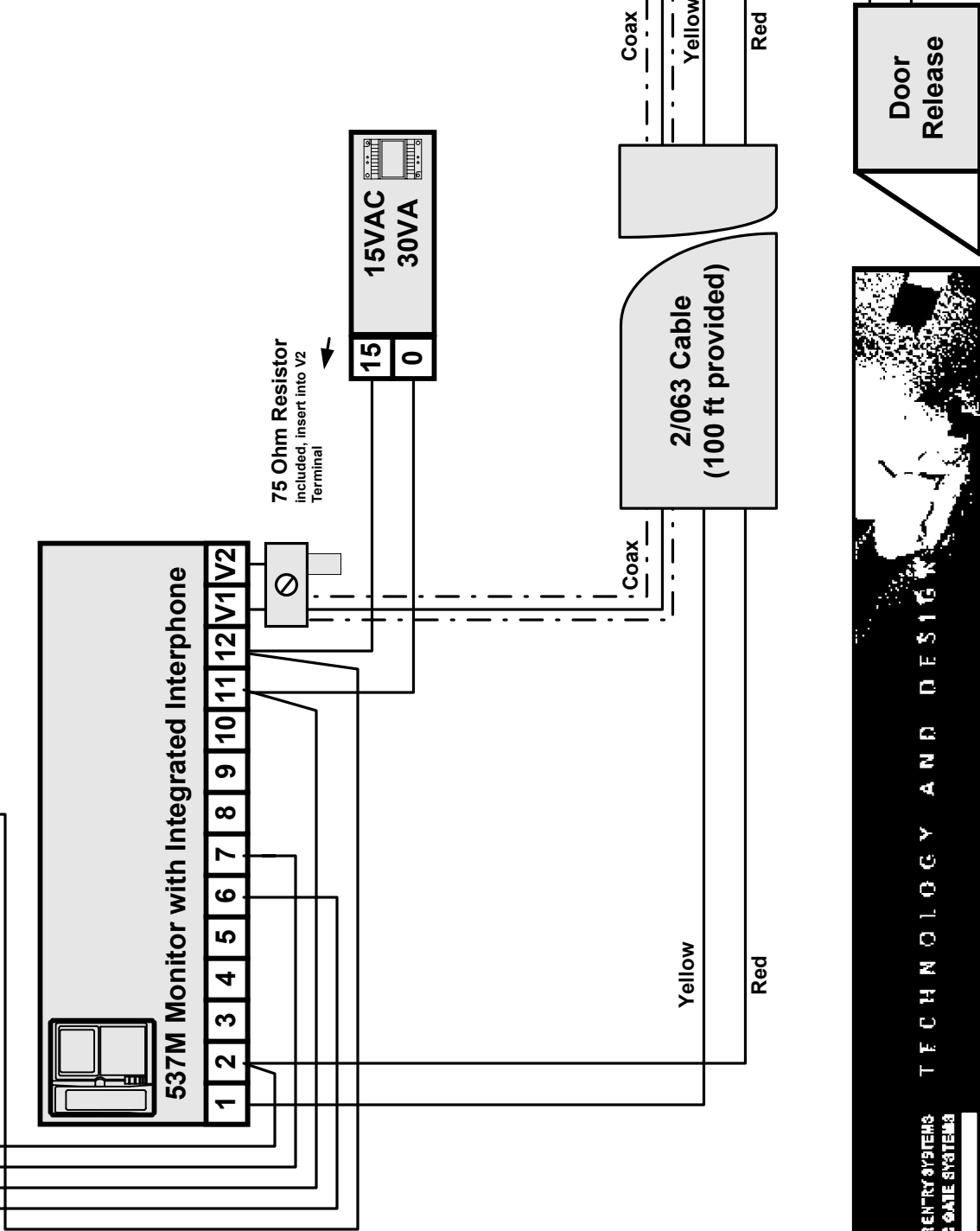

**Adding Optional Extension Chime to any
537 Kit:
Order:
Qty 1 2/841 Chime**

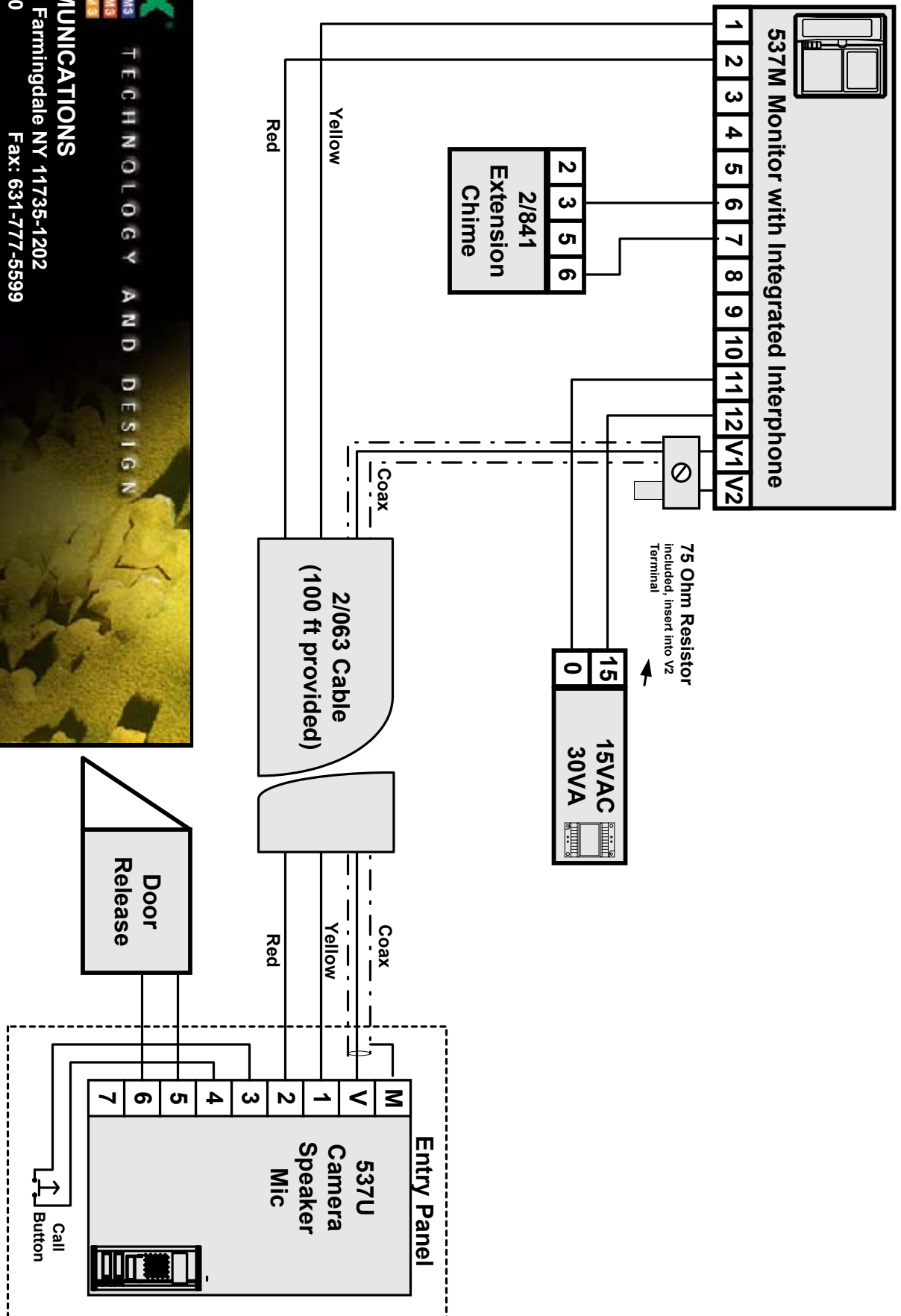

EDVAX
 VIDEO DOOR ENTRY SYSTEMS
 AUTOMATIC GATE SYSTEMS
 TELEPHONE SYSTEMS
 TECHNOLOGY AND DESIGN
ALPHA COMMUNICATIONS
 42 Central Drive, Farmingdale NY 11735-1202
 Tel: 631-777-5500 Fax: 631-777-5599
 Email: info@alpha-comm.com Web www.alpha-comm.com

Adding Optional Doorbell Pushbutton to any 537 Kit:

Wire any N.O momentary switch as shown below

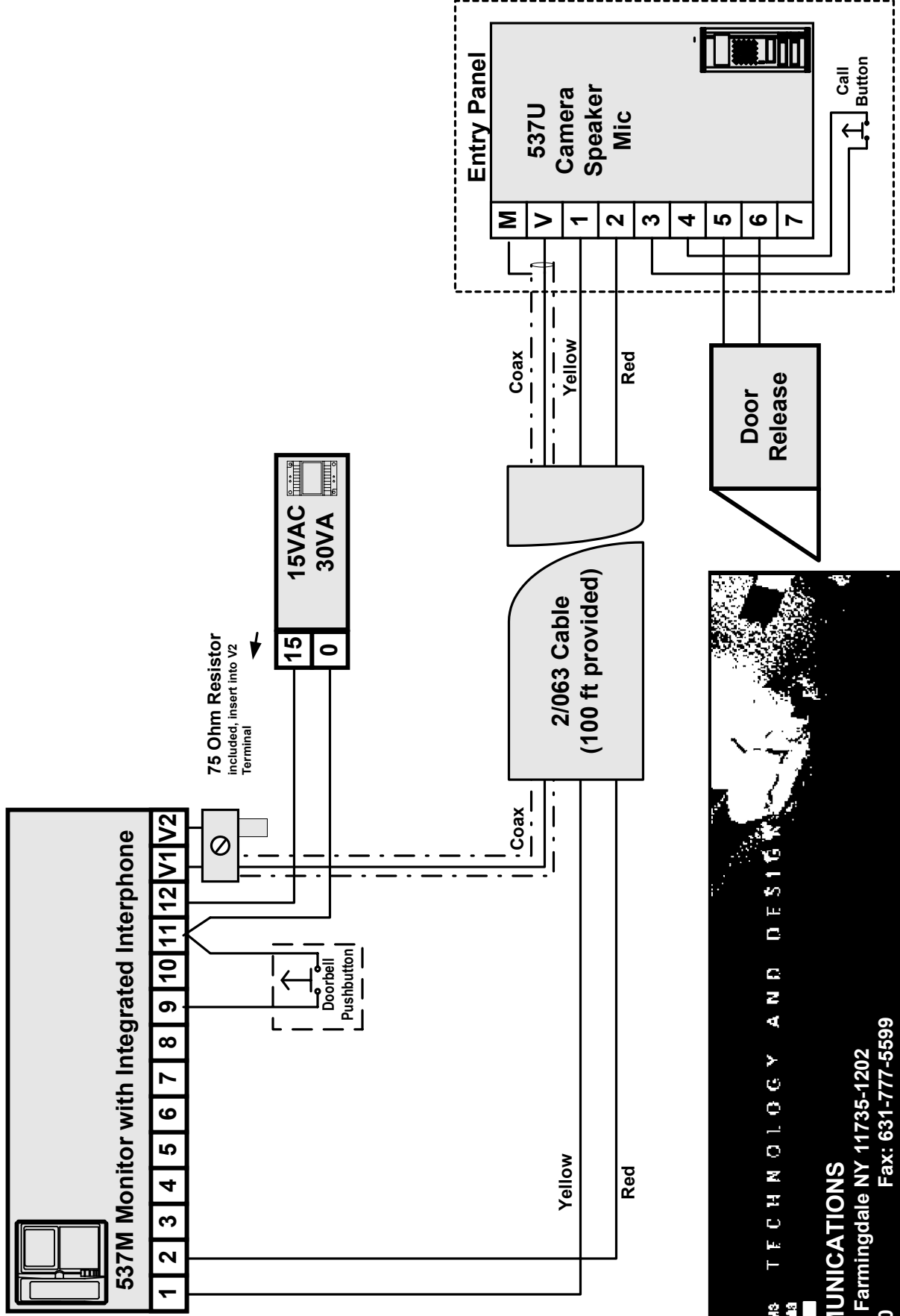

VIDEO SURVEILLANCE SYSTEMS
 TECHNOLOGY AND DESIGN
 ALPHA COMMUNICATIONS
 42 Central Drive, Farmingdale NY 11735-1202
 Tel: 631-777-5500 Fax: 631-777-5599
 Email: info@alpha-comm.com Web www.alpha-comm.com

Adding Optional Relay that is energized while monitor is on any 537 Kit:

Order:
Qty 1 170/001 Relay

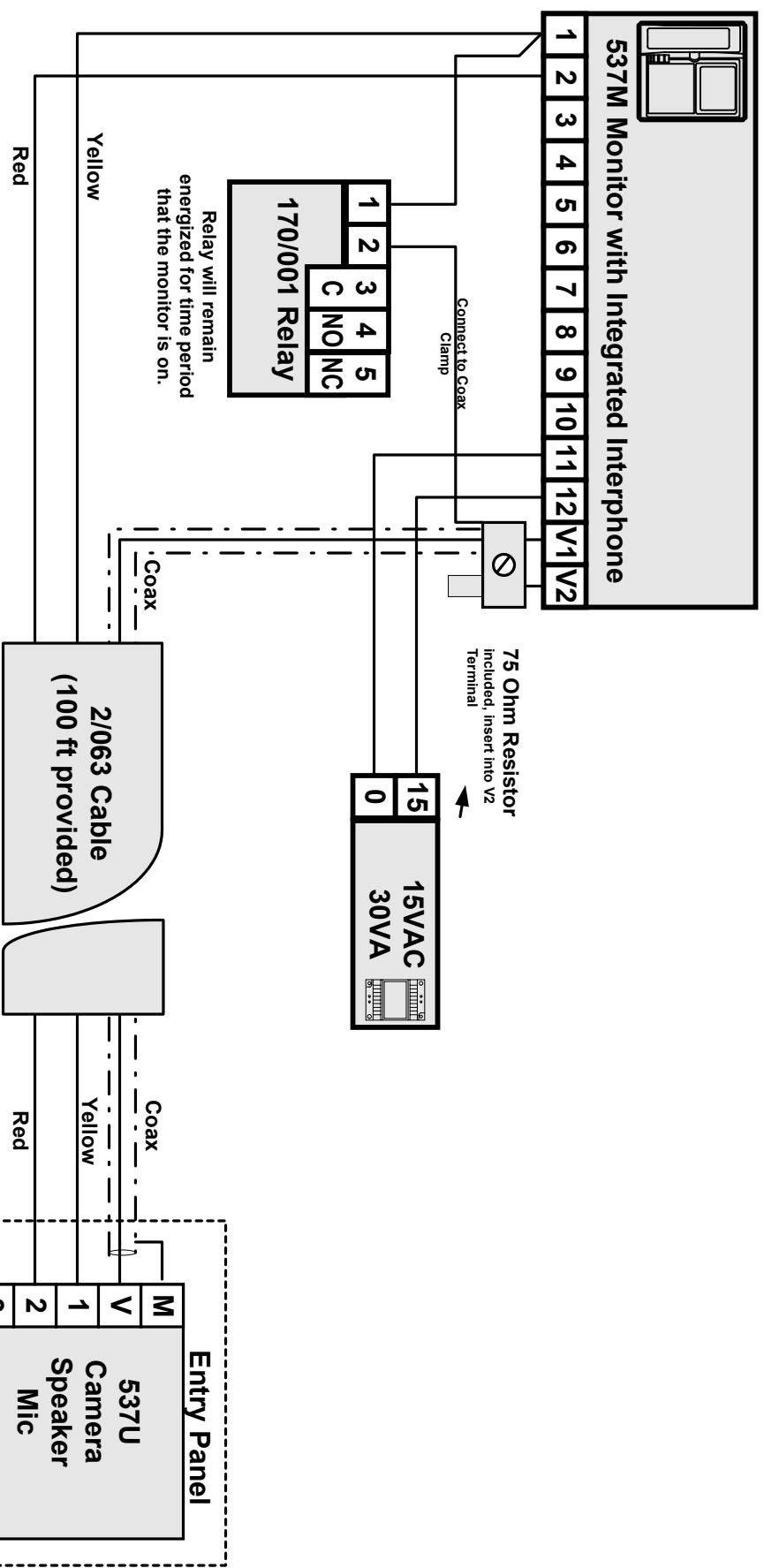

EDVAX
VIDEO DOOR ENTRY SYSTEMS
AUTOMATIC GATE SYSTEMS
TELEPHONE SYSTEMS

TECHNOLOGY AND DESIGN

ALPHA COMMUNICATIONS
42 Central Drive, Farmingdale NY 11735-1202
Tel: 6531-777-5500 Fax: 631-777-5599
Email: info@alpha-comm.com Web www.alpha-comm.com

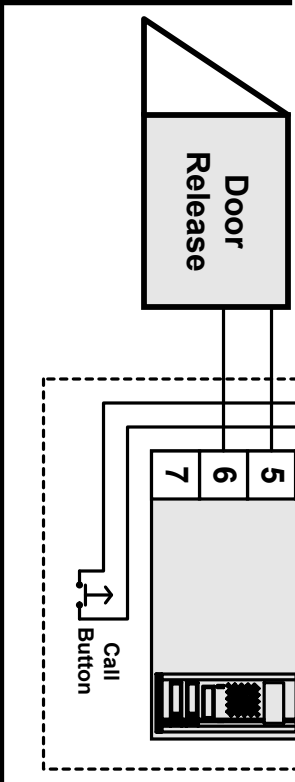

**Adding Optional Relay that is energized while monitor light pushbutton is depressed on any 537 Kit:
Order:
Qty 1 170/001 Relay**

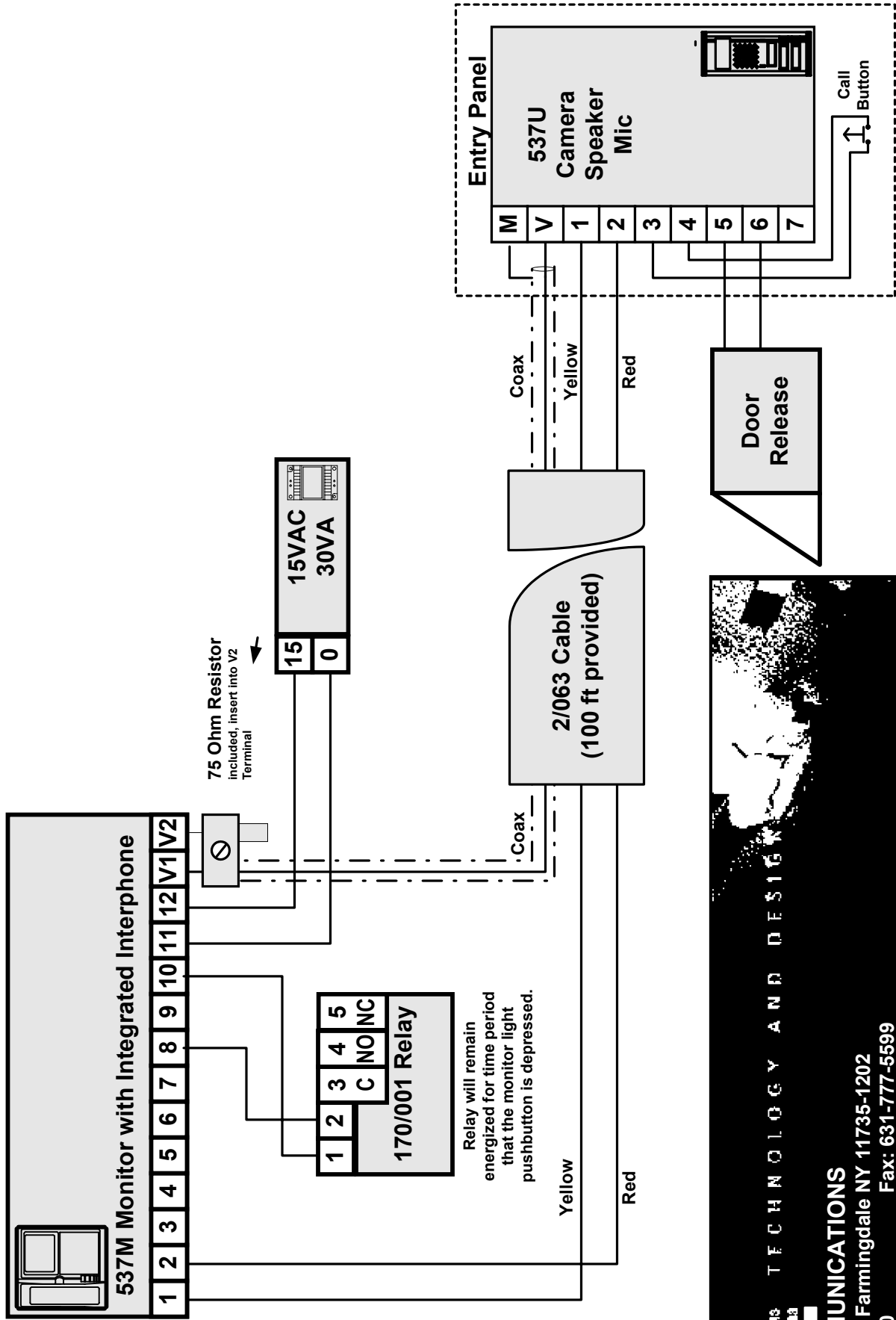

VIDEO SURVEILLANCE SYSTEMS
AUTOMATIC DIAL SYSTEMS

TECHNOLOGY AND DESIGN

ALPHA COMMUNICATIONS
42 Central Drive, Farmingdale NY 11735-1202
Tel: 631-777-5500 Fax: 631-777-5599
Email: info@alpha-comm.com Web www.alpha-comm.com

Adding Optional Relay that is energized during call signal on any 537 Kit:

Order:
Qty 1 170/101 Relay

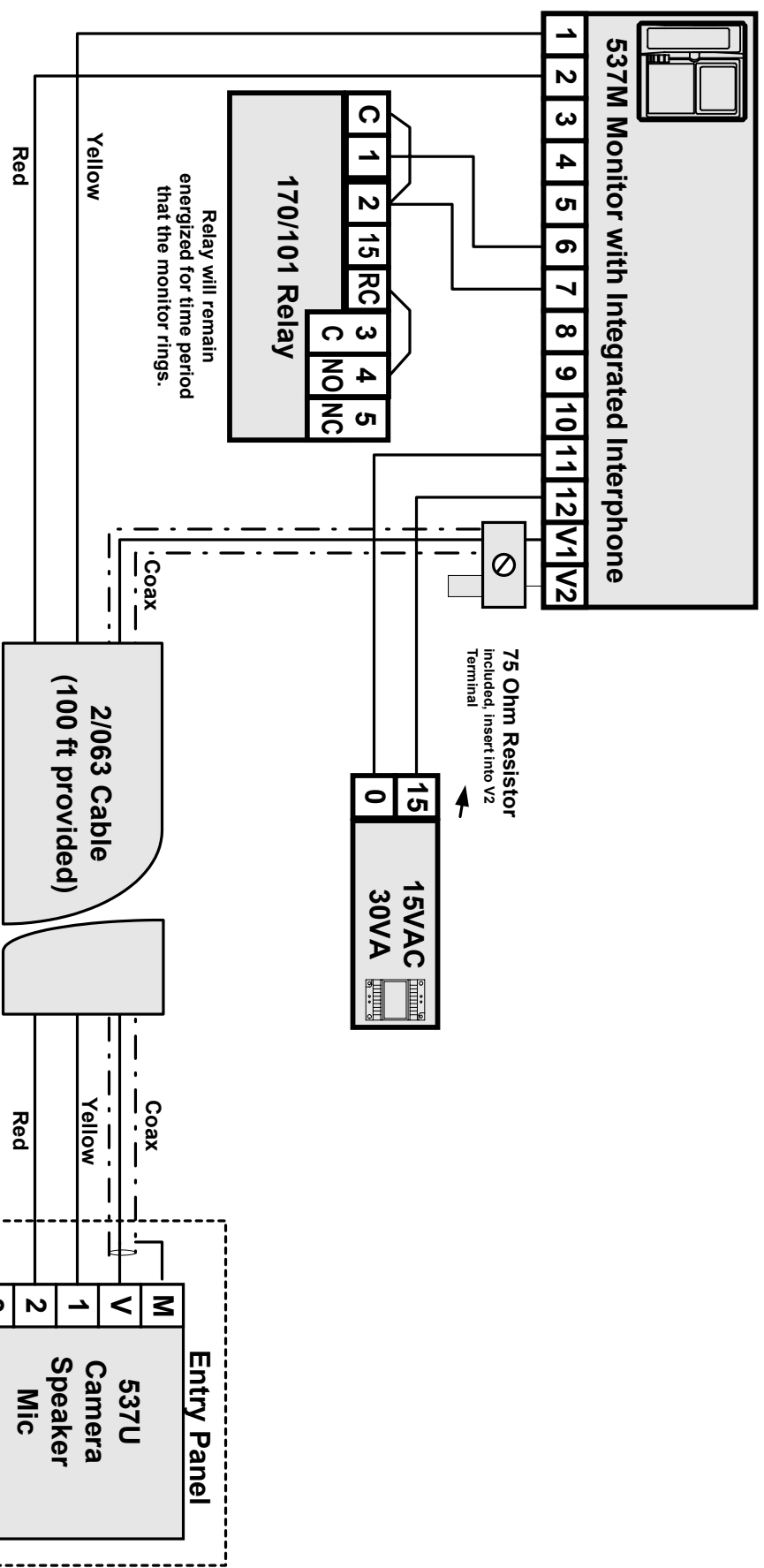

VIDEO DOOR ENTRY SYSTEMS
AUTOMATIC GATE SYSTEMS
TELEPHONE SYSTEMS

TECHNOLOGY AND DESIGN

ALPHA COMMUNICATIONS

42 Centvral Drive, Farmingdale NY 11735-1202
Tel: 631-777-5500 Fax: 631-777-5599
Email: Info@alpha-comm.com Web www.alpha-comm.com